

PVC-U System

Optima Sculptured Windows and Doors

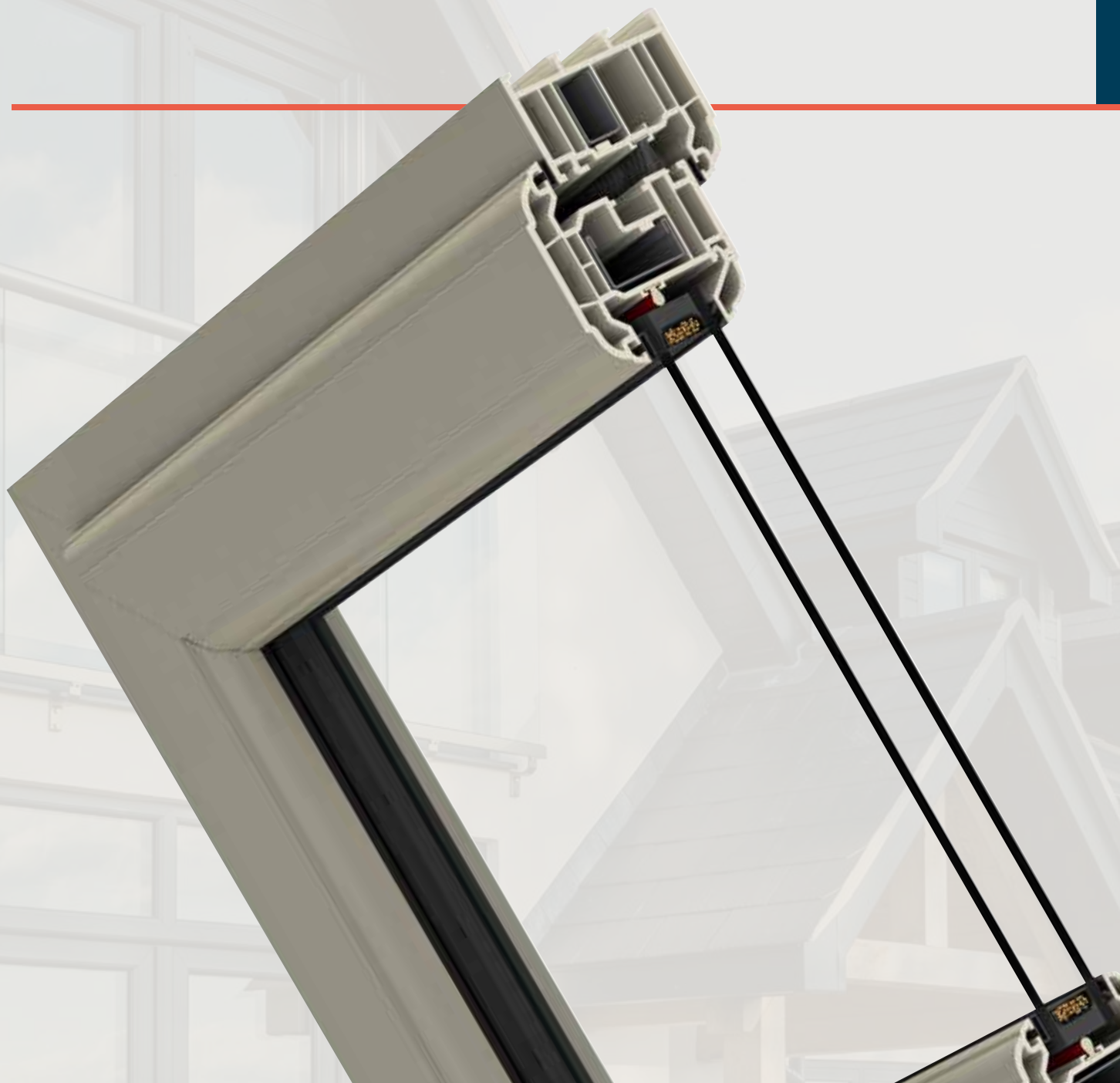

EpwinTM
window systems

The most advanced PVC-U window system on the market

Epwin Window Systems is the UK's leading manufacturer of PVC-U window systems and home to Optima, the fully integrated, award-winning PVC-U window and door system designed to deliver the best of everything. Welcome to more options and more possibilities with the Optima Sculptured System from Epwin Window Systems.



An award-winning system

Optima is an award-winning system that represents the best the industry has to offer. The sculptured system within Optima offers impressive design flexibility with a gently curved frame shape that's at home in every type of property. As the independent judging panel said: "This suite of profiles seems to provide an answer to most window needs." When you work with Optima, you'll see what they mean.



Designed to offer the best of everything

Optima was designed from the ground up to be an efficient to fabricate and easy to fit system that looks better and performs better than any other system on the market. It has intelligently designed features throughout the system which offers a whole new level of technical innovation. It's why Optima gives you a clear competitive edge.



Delivering what the market needs

Whether you work in the domestic replacement, new build, refurbishment, commercial or public sectors, the Optima Sculptured System has the features and technical innovation these markets demand. Outstanding aesthetics and design flexibility. Exceptional security. Impressive thermal efficiency. When you want to deliver above and beyond, Optima is the answer. In short, it is the best PVC-U system available today.



Driving your business forward

Alongside Optima itself, you also get the support of Epwin Window Systems, the powerhouse in PVC-U systems. From technical expertise and marketing know-how to commercial opportunities and more, we bring support that adds value to your business at every level and across all sectors. It's just one more reason why Optima is the system your business needs.

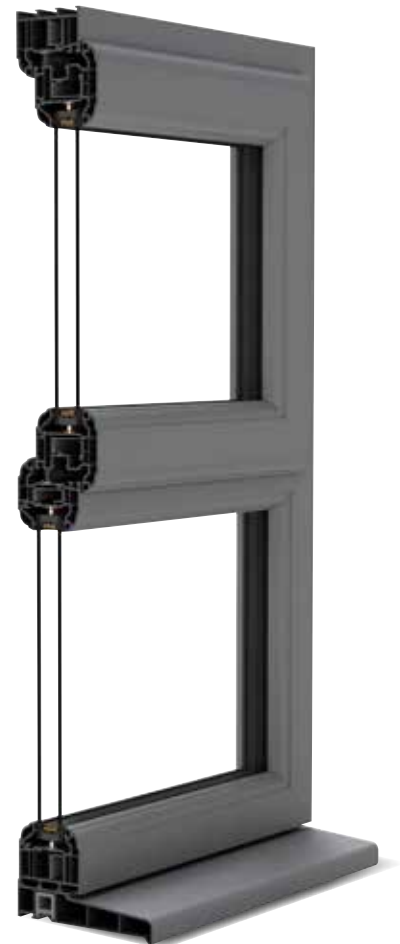



A truly British heritage

Optima is produced by Epwin Window Systems, the UK's largest systems house with a track record stretching back nearly 50 years.

We offer the widest portfolio of fully integrated window and door systems, a choice of leading brands, with unrivalled expertise and support to grow your business.

We firmly believe in continuous investment in our production facilities and operations. Our approach means we are able to provide the levels of quality and reliability you have a right to expect.

Our products are designed and manufactured in Britain for the British market. We are active in trade and industry bodies and we take a leading stance in environmental initiatives. Our commitments mean you are able to rely on us to be a proactive partner that adds value to your business.

Because when you work with Epwin Window Systems you get more options and more possibilities.

**MADE IN
BRITAIN** 



The Optima difference

Benefits of Optima

Optima is a fully integrated, 70mm Sculptured system which offers superior all-round performance. It's suitable for a wide range of projects and for many applications, including casement, tilt & turn, French casement windows, and both residential and French doors.



Better insulated

The 6-chambered outerframe and 5-chambered sash plus bigger glass area means Optima offers excellent thermal performance. It can achieve U-values as low as 0.8 W/m²K and A++ Window Energy Ratings (WER).



Superb weather protection

The revolutionary centre seals to the outerframe and sash plus the 10mm sash cover deliver enhanced insulation and weather protection. Superb performance, no matter how demanding the conditions.



Widest choice of ancillaries

Optima has the widest range of ancillaries on the market, including cills, baypoles, accessories and packers. All the design flexibility you need so you can deliver perfect projects every time.



Widest choice of glazing options

Optima offers a comprehensive range of double and triple glazed options. It's cost-effective too – our triple glazing achieves U-values below 1 without the use of krypton gas. More ways to offer affordable and energy-efficient windows.



Better drainage

Optima incorporates deeper drainage channels that carry water away quickly and improve weather performance. A system that offers superb long-term durability – and means fewer service call-outs and reduced ongoing costs.



Superior security and strength

Optima has features such as a central Eurogroove that gives the sashes greater rigidity and strategic local wall thickening for 35% better screw and hardware retention. Intelligent features that maximise security and strength.



Built to last

Optima has been designed to be simple to fabricate and install, and surpasses Building Regulations and PAS 24:2016. It is highly accredited and has Secured by Design approval. A superior-quality system, built for life.



Optima Casement Window System

The classic window design with all the options you need.

The Optima Casement Window is suitable for almost any size of aperture or design layout, including bay and bow windows. It is an internally glazed system that can be specified with single top or side hung openers and multi-lights.



Product features

- 1 Sculptured edge design
- 2 24, 28, 36, 40 & 44mm glazing options
- 3 5-chamber sash (with optional RCM inserts available)
- 4 Outer frame / sash centre seals
- 5 10mm cover on weather seals
- 6 6-chamber outer frame (with optional RCM inserts)

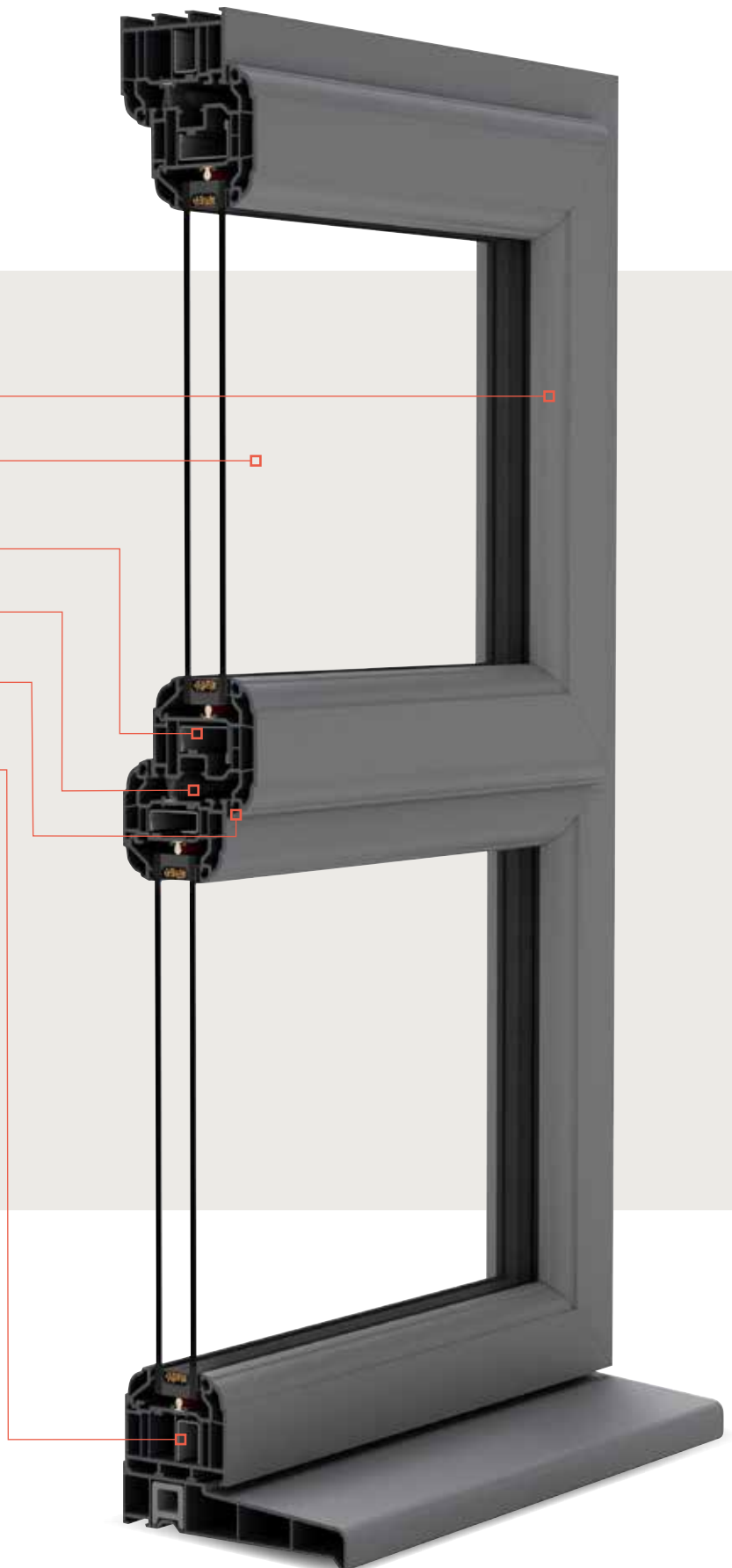

Every element of the Optima Casement Window has been carefully considered. Whether it's outstanding aesthetics, exceptional security or impressive thermal efficiency, Optima more than delivers – and all in a system designed to be easy to fabricate and simple to install.

Optima French Casement Window System

Ideal for dormers, cottage and smaller window apertures.

The Optima French Casement Window, with its symmetrical opening panes, offers good ventilation, unrestricted views and the possibility of an emergency-escape route. Offering an impressive glass-to-frame ratio due to the slim, unobtrusive profiles, the Optima French Casement Window delivers the best ratings for passive solar gain.



Product features

- 1 Sculptured edge design
- 2 24, 28, 36, 40 & 44mm glazing options
- 3 5-chamber sash (with optional RCM inserts available)
- 4 Outer frame / sash centre seals
- 5 10mm cover on weather seals
- 6 6-chamber outer frame (with optional RCM inserts)

As with all Optima products, the French Casement Window offers exceptional weather tightness and thermal insulation making it a window suitable for all applications.

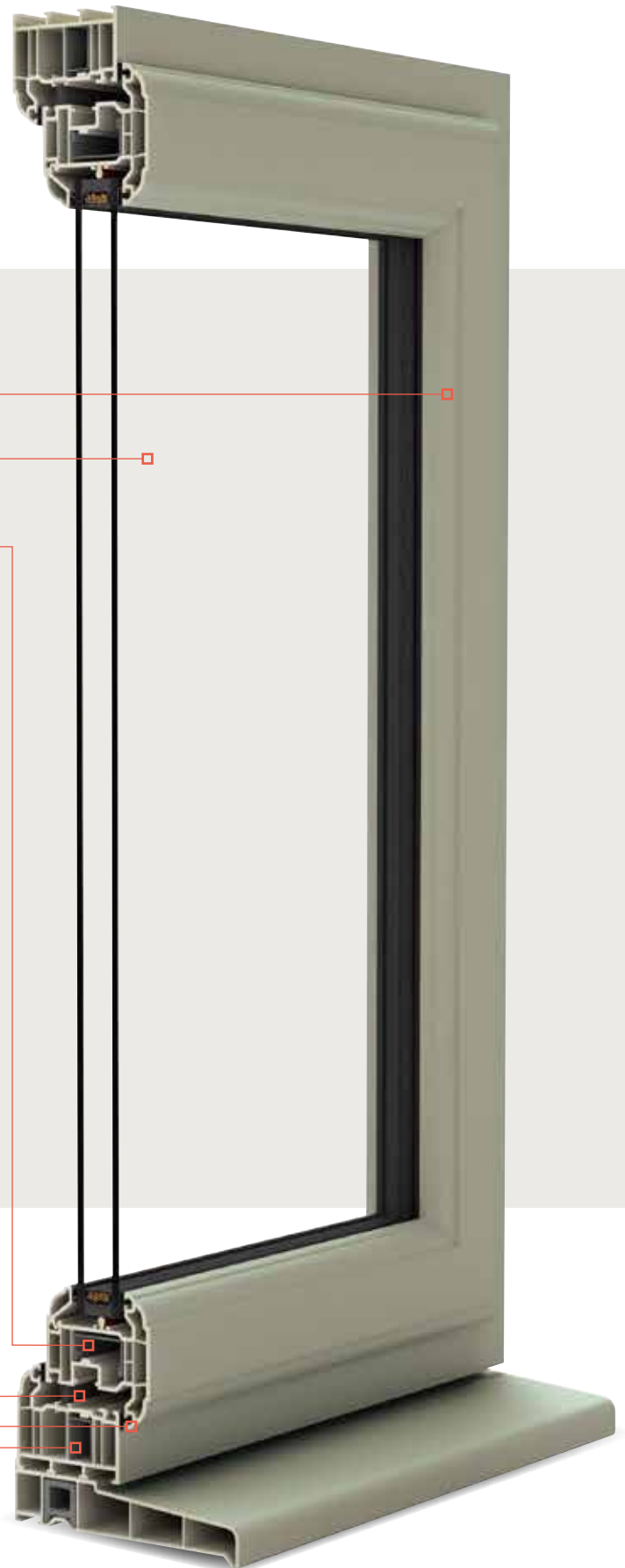

Optima Tilt & Turn Window System

A stylish, practical window for high, exposed or difficult access locations.

The Optima Tilt & Turn Window offers superior sightlines and a higher glass-to-frame ratio, which makes it an excellent choice for commercial projects. The reassurance of secure all-round locking delivers a reliable and strong window with superb overall aesthetics due to its elegant and streamlined frame aesthetics.



Product features

- 1 Sculptured edge design
- 2 24, 28, 36, 40 & 44mm glazing options
- 3 Concealed hardware
- 4 Optional sash & outer frame centre seals
- 5 5-chamber sash
- 6 5-chamber outer frame with optional RCM inserts available

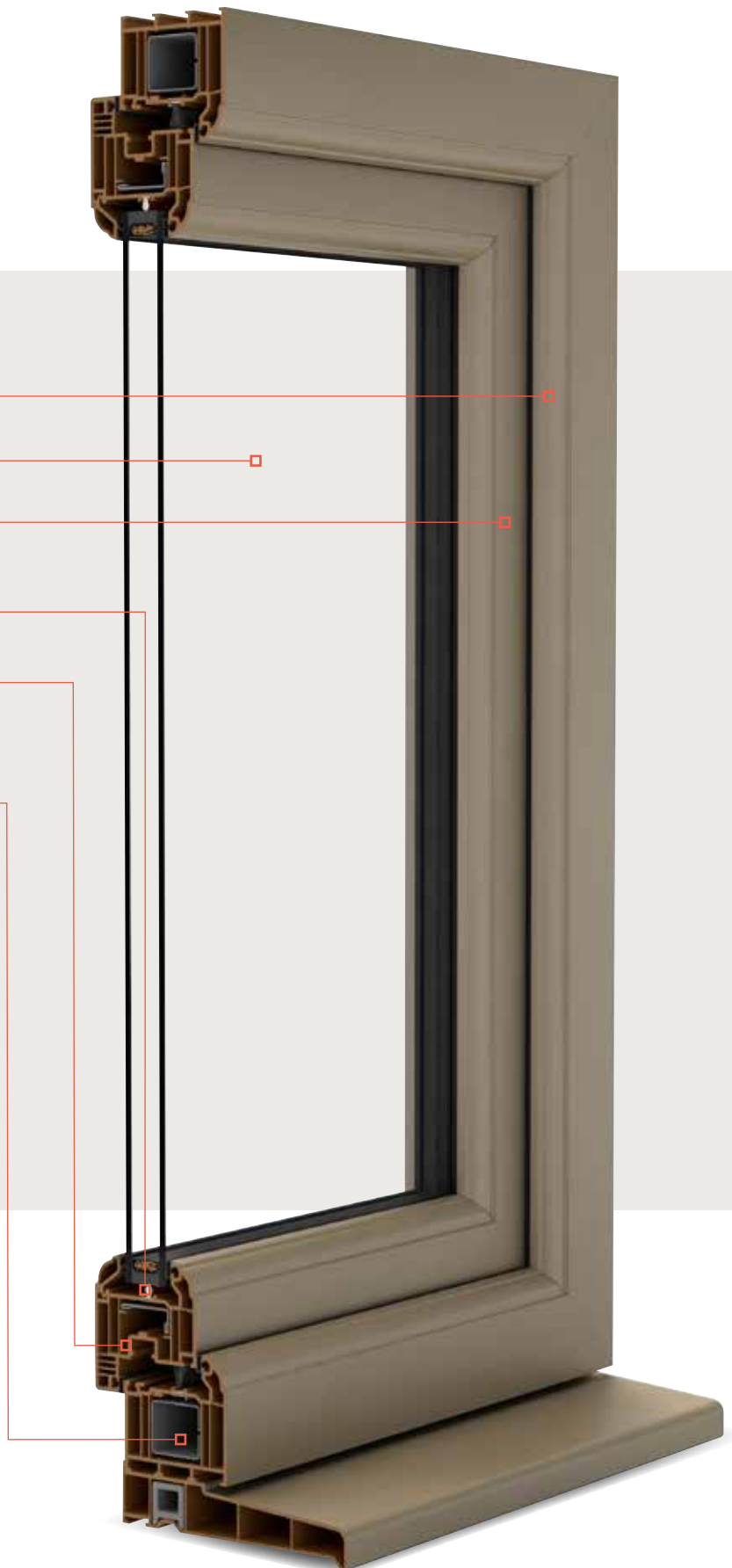

As with all Optima products, a wealth of options from colour to thermal efficiency to security, gives you the scope you need.

Optima Residential and French Door System

Optima Residential and French Doors offer a perfect match with Optima windows.

Both products have been meticulously designed to offer a wealth of aesthetic and practical options including high-quality functionality, durability, performance, finish and security so you can tailor every project to the most precise of specifications.



Product features

- 1 Sculptured edge design
- 2 24, 28, 36, 40 & 44mm glazing options
- 3 Optional sash centre seals
- 4 5-chamber open in / open out sash
- 5 Part Q & M compliant



Ancillaries

The widest choice of ancillaries on the market.

No project is ever the same, not all buildings are standard and every customer has individual requirements.

The Optima range of ancillaries includes bay assemblies, coupling sections, frame packers, ancillaries and finishers. All can be perfectly colour-matched and offer the same high-quality durability as our main system components for a perfect seamless finish.

It means you can create perfectly fitting, perfectly designed projects every time and more than deliver on customer expectations.

Cills

Complete with end caps and couplers, our cill sizes range from a modest 85mm to a substantial 225mm. There's a single reinforcing size to help keep your stockholding under control and steel and recycled composite material (RCM).



Thermal Inserts

Thermal inserts are an effective way to achieve better U-values and WERs without the cost of the most highly-insulating sealed units. Simple to use and cut, they slot inside the profiles during fabrication, increasing the number of insulating chambers. What's more, they're made from recycled materials, enhancing your green credentials.



Baypoles

A range of baypoles enables the installation of strong and robust bay and bow windows. With variable, square and fixed angle variants, all shapes and sizes of immaculately-finished installation are possible.

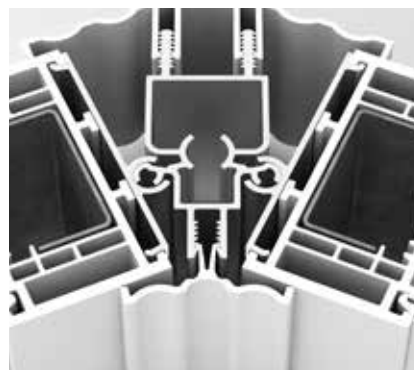



Couplers

Couplers are available in a range of sizes from 3mm to 29mm.

Weatherbars

Ideal for Optima French or residential doors, weatherbars provide the important finishing touches to an installation.

Packers

Packers are available in four sizes ranging from 15mm to 50mm.

Casement Horns

Run-through casement horns and cover caps are available in all Optima stock colours and finishes.

Astragal Bars

A choice of sculptured and chamfered glazing bars is available in all Optima colours and finishes.



The Colour Collection

Our Colour Collection brings a wealth of design flexibility to every project.

It features an array of shades from modern classics such as Anthracite Grey and heritage hues such as Chartwell Green to the palettes of the future such as Claystone. Dual colour options are also available, bringing the option of different interior and exterior colours. Profiles are wrapped in our state-of-the-art colour production facility to ensure the quality of finish remains pristine.

Base appeal

To maximise your product offer further, we also offer complementary base colours on our foiled ranges to deliver higher-value aesthetics. These include white, grey, brown, tan and cream and are designed to perfectly complement our foils and deliver the next level in coloured profile aesthetics.

Stock Colours

Premium



Anthracite Grey /
White (PVC-U)
(White Base)



Anthracite Grey /
Anthracite Grey
(Grey Base)



Rosewood /
White (PVC-U)
(White Base)



Rosewood /
Rosewood
(Brown Base)



Black Brown /
White (PVC-U)
(White Base)



Black Brown /
Black Brown
(Brown Base)



Light Oak /
White (PVC-U)
(White Base)



Light Oak /
Light Oak
(Tan Base)

Premium Plus



Cream /
White (PVC-U)
(White Base)



Cream /
Cream
(Cream Base)



White Woodgrain /
White Woodgrain
(White Base)

Fast Track Colours

Premium



Anthracite Grey Smooth /
White (PVC-U)
(White Base)



Anthracite Grey Smooth /
Anthracite Grey Smooth
(Grey Base)



Chartwell Green/
White (PVC-U)
(White Base)



Agate Grey/
White (PVC-U)
(White Base)



Slate Grey/
White (PVC-U)
(White Base)



Sage Smooth /
White (PVC-U)
(White Base)



Pebble Grey /
White (PVC-U)
(White Base)



Claystone /
White (PVC-U)
(White Base)



Made to Order Colours

Made to Order Colours are available with white PVC-U internal faces, or foiled on both sides on a complementary base colour for better looking installations.

Cream Base	Tan Base	Brown Base	White Base	Grey Base	
Cream	Irish Oak	AnTeak	White	Black Ulti-Matt	Slate Grey
Claystone	Honey Oak Super-Matt*	Swamp Oak	Dark Red	Silver D Smooth*	Anthracite Grey
Pebble Grey	Light Oak	Rosewood	Steel Blue	Hazy Grey	Anthracite Grey Smooth
Windsor	Pyrite	Black Brown	Dark Green	Kensington Grey	
Sage Smooth		Flemish Gold Smooth		Buckingham Grey	
Agate Grey				Basalt Grey Smooth	
Chartwell Green				Slate Grey Finesse	

Range of reliable hardware

Our hardware brand, Safeware, is one of the UK's leading suppliers to the industry, offering a complete range, including trusted household names like Yale.



A multitude of benefits.

We know that quality hardware more than delivers return on investment in reduced call backs, maintenance and performance.

And when you order your hardware from us you can be confident that all products are compatible with Epwin Window Systems, putting an end to checking specifications or calling suppliers with queries.

You can order profiles and hardware on the same order and the same delivery. It streamlines admin, accounting and goods inwards processes and saves time.

Finally, high stock levels and rapid delivery from our Telford warehouse mean there's no need to worry about product availability or delays to schedules.



Optima gives you peace of mind

As the UK's leading systems brand, Epwin Window Systems holds all the accreditations you need to meet your requirements.



BS EN ISO 9001
BSI Registered firm scheme: Quality Management Systems.



BS EN ISO 14001
Manufactured under an ISO 14001 Registered Environmental Management System.



BS ISO 45001
Occupational Health and Safety Management Systems.



BS EN 12608/PAS 24
Enhanced Security Window System Supplier.



BS EN 12608/PAS 24
Enhanced Security Door System Supplier.



BS EN 12608
PVC-U Profiles for the Fabrication of Windows and Doors.



BS 8529/PAS 24
Enhanced Security Composite Door System Supplier.



Secured by Design
The UK Police initiative supporting the principles of 'designing out crime' by use of crime prevention and security standards.



VinylPlus
A labelling scheme to identify the most sustainable and high-performance PVC-U products.

Tested to the highest standards

Every aspect of the Epwin Window Systems range is continually tested and assessed to ensure it offers excellence in every respect. All Optima products meet current Building Regulations as standard and many can provide solutions far above these requirements. It means that no matter how demanding your project, Optima delivers.

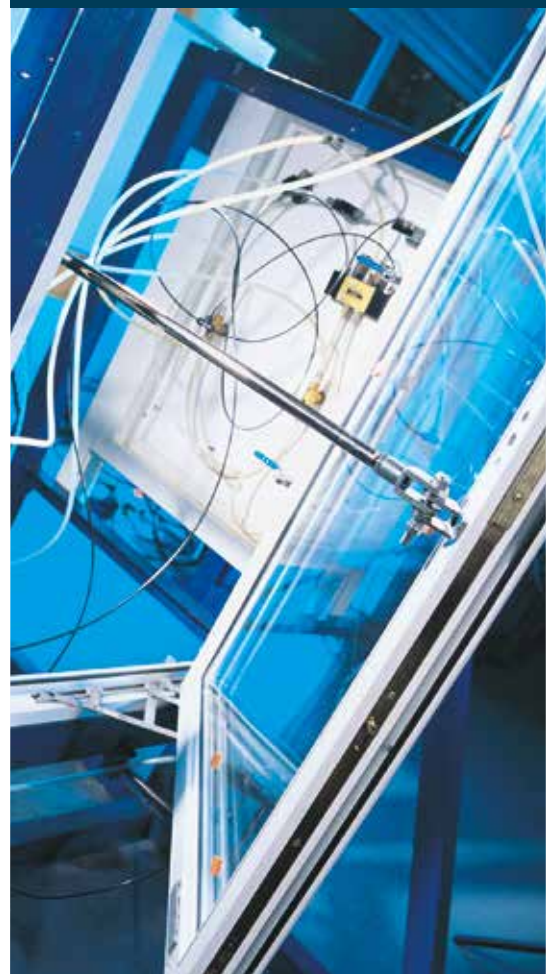

Security benefits

Security on Optima is second to none, thanks to innovative features and intelligent design.

Optima can accommodate the very latest in high-security hardware, advanced multipoint locks, keeps and key-locking handles. The system also includes strategically placed local wall thickening, which gives 35% better screw and hardware retention. There is a central Eurogroove built in as standard to ensure the sashes have greater strength and rigidity and are less susceptible to manual attack.

The features mean that Optima can easily deliver Secured by Design specifications when required.

Secured by Design



Official Police Security Initiative



Thermal efficiency

Optima meets and exceeds all requirements for thermal efficiency as standard. Intelligent options mean it is also capable of delivering to the highest of specifications.

There are features such as six thermal chambers in the outerframe (eight with RCM thermal inserts) and five in the sash (six with RCM thermal inserts). Optional centre seals to the outerframe and sash deliver even more insulation. Double and triple glazing offer further options.

It all means that no matter how demanding the thermal efficiency specification, Optima can deliver.

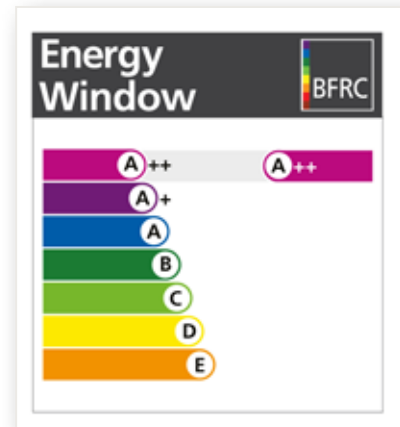

Optima Sculptured System Product Data



Casement Window

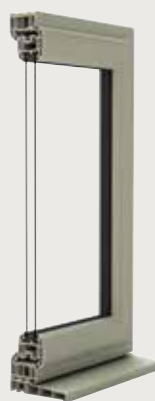

French Casement Window

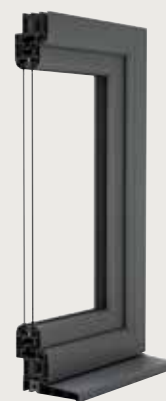

Tilt & Turn Window

PERFORMANCE & ACCREDITATION	Top Hung		Side Hung	
U-value (double glazing)	1.2 W/m ² K		1.2 W/m ² K	1.2 W/m ² K
U-value (triple glazing)	0.8 W/m ² K		0.9 W/m ² K	0.8 W/m ² K
Energy Rating (WER)	A++		A+	A++
Green Guide Rating #	A		A	A
Acoustic Performance-various options depending on specification-RW (C;Ctr)	36 to 44		36 to 44	36 to 44
Air Tightness (Pa)	Class 3 (600Pa)	Class 4 (600Pa)	Class 2 (300Pa)	Class 4 (600Pa)
Water Tightness (Pa)	Class 9A (600Pa)	Class E1500 (1500Pa)	Class 7A (300Pa)	Class E750 (E750Pa)
Wind Loading (Pa)	Class BE2400 (2400Pa)	Class CE2400 (2400Pa)	Class B4 (1600Pa)	Class CE2400 (2400Pa)
Security	PAS 24		PAS 24	PAS 24
PAS 24 Size Limits (mm)	1240 x 1240	740 x 1340	740 x 1277	1436 x 1535
Secured by Design (SBD)	✓		✓	✓

CONFIGURATIONS				
Top Hung Outward	✓			
Side Hung Outward	✓		✓	
Fixed Light	✓		✓	✓
Multilight	✓		✓	✓
Tilt & Turn				✓

SASH WEIGHT & SIZE LIMITS				
Maximum Sash Weight*	50 kg	40 kg	40 kg	130 kg
Maximum Sash Size (mm)	1240 x 1240	740 x 1340	740 x 1340	1426 x 1540

SYSTEM FEATURES				
System Depth (mm)	70		70	70
Multipoint Locking	✓		✓	✓
Glazing Options	Internally & Externally Beaded		Internally & Externally Beaded	Internally Beaded
Glazing Thickness (mm)	24/28/36/40/44		24/28/36/40/44	24/28/36/40/44



Residential Door



French Door

PERFORMANCE & ACCREDITATION		
U-value (double glazing)	1.2 W/m ² K	1.2 W/m ² K
U-value (triple glazing)	0.8 W/m ² K	0.8 W/m ² K
Energy Rating (DSER)	A++	A+
Green Guide Rating #	A	A
Acoustic Performance-various options depending on specification-RW (C;Ctr)	36 to 44	36 to 44
Air Tightness (Pa)	Class 2 (300Pa)	Class 2 (300Pa)
Water Tightness (Pa)	Class 3A (100Pa)	Class 3A (100Pa)
Wind Loading (Pa)	Class A3 (1200Pa)	Class A3 (1200Pa)
Security	PAS 24	PAS 24
PAS 24 Size Limits (mm)	1000 x 2151	1000 x 2151
Secured by Design (SBD)	✓	✓
CONFIGURATIONS		
Single Door	✓	
Double Door		✓
Fixed Light	✓	✓
SASH WEIGHT & SIZE LIMITS		
Maximum Sash Weight*	120 kg	120 kg
Maximum Sash Size (mm)	1000 x 2151	1000 x 2151
SYSTEM FEATURES		
System Depth (mm)	70	70
Multipoint Locking	✓	✓
Glazing Options	Internally Beaded	Internally Beaded
Glazing Thickness (mm)	24/28/36/40/44	24/28/36/40/44

* Hardware dependent

For more information about Epwin Window Systems products visit
www.epwinwindowssystems.co.uk



Epwin[™]
window systems

Epwin Window Systems is a manufacturer of PVC-U and aluminium profile systems, supplied to independent manufacturers and installers who contract to install windows, doors and conservatories. Epwin Window Systems cannot be held accountable for manufacture or installation by independent companies. All information in this publication is provided for guidance only and is given in good faith. As it is company policy to continually improve products, methods and materials, changes of specification may be made from time to time without prior notice. This statement does not affect your statutory rights. © Epwin Window Systems. Part of the Epwin Group Plc. EWS17511