



SIDE SLIDING SECTIONAL DOORS

NEW. Sliding door version as a space-saving alternative to hinged doors

HÖRMANN



4



12



20

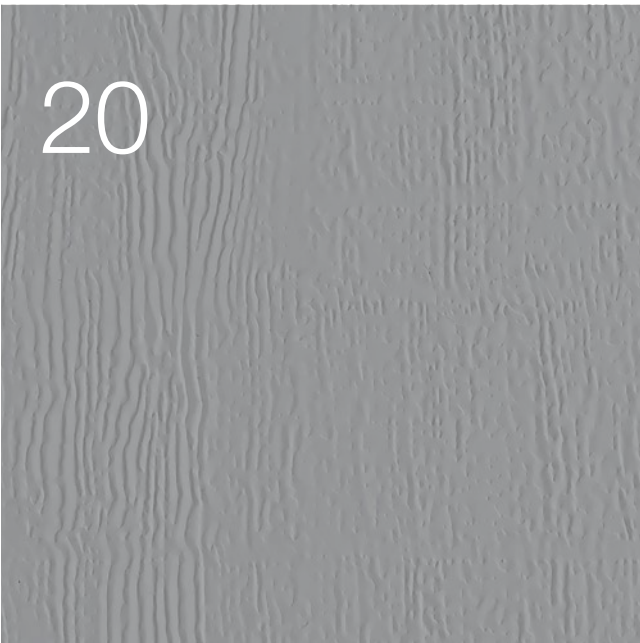

Content

4 **Good reasons to try Hörmann**

12 **Inspirations**

12 Woodgrain surface finish

13 Silkgrain surface finish

14 MatchColor

15 Side doors

16 Decograin surface finish

17 Duragrain surface finish

18 Design and light elements

19 Aluminium frame door HART 42

20 **Design, equipment, accessories**

20 Steel sectional doors

22 Aluminium frame doors

23 Glazings and ventilation grilles

24 Surface finishes

32 Equipment

35 Sliding doors

36 Side doors

38 Operators

40 Accessories

42 Dimensions and technical manual

Responsibility for generations

The Hörmann family business has over 85 years of experience as a construction component specialist. This gives us an obligation to both current and future generations. That's why environmental responsibility plays such an important role for us. With this in mind, we develop innovative solutions for sustainable products and intelligent environmental protection.



“A GOOD REPUTATION MUST BE EARNED.”

August Hörmann

In keeping with the tradition started by the company's founder, the Hörmann brand is a true promise of quality and, with sales of over 20 million doors, door frames and operators, is one of Europe's most successful suppliers. Due to the comprehensive international sales and service network, Hörmann is your strong partner for high-quality construction components.

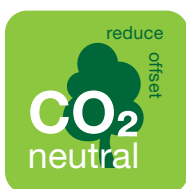

WE THINK AND ACT GREEN. As a family business, we are very conscious of our responsibility to future generations. The Hörmann climate protection strategy aims to reduce and avoid CO₂ emissions. We cover 100% of our electrical power needs at all European production locations with purchased green electricity. We are also investing in a clean future with other measures such as the use of recycled paper, CO₂-neutral postal shipping and the recycling of transport packaging to save more than 75,000 tons of CO₂ every year. We work with ClimatePartner to offset the emissions that we do generate by supporting certified climate protection projects. In particular, we offset all CO₂ emissions produced in manufacture of products for residential construction as standard.



You can find further information at
www.hoermann.com/sustainability



ClimatePartner
certified product
climate-id.com/XNEBKC



CO₂
measure
reduce
contribute

Brand quality made in Germany



The family-owned company Hörmann offers all important construction components for building and renovating projects from a single source. We manufacture in highly specialised factories using state-of-the-art production technologies. Our employees work intensively on new products, continual further developments and improvements to details. The results are patents and unique products on the market.





10-year
warranty*

LONG-LASTING. GUARANTEED. All major door and operator components are developed and manufactured by Hörmann. Endurance tests under real conditions ensure mature series products with Hörmann quality. Thanks to this and uncompromising quality assurance, you receive a 10-year warranty on all Hörmann sectional doors and a 5-year warranty on Hörmann operators*.

* The complete warranty conditions can be found at: www.hoermann.com



Tested and
certified

Certified safety for you and your family. Hörmann side sliding sectional doors are tested and certified in accordance with the high safety requirements of European standard 13241, not only on their own but also in combination with Hörmann operators. It would be hard to find a safer side sliding sectional door. And this provides you and your family with safety during daily use.



Discover the space you could save

In contrast to up-and-over doors, sectional doors and roller garage doors, side sliding sectional doors open to the side instead of upwards. This is particularly advantageous if, for example, the garage ceiling has to remain free to store items (such as surfboards), or the door leaf cannot be parked underneath or fitted to the ceiling due to construction reasons (a sloped roof, low lintel, obstructive drainpipes).





RELIABLE. Optimally shaped door section transitions and hinges prevent fingers from being accidentally trapped. The reliable automatic safety cut-out is active during both the opening and the closing cycle of the door. The door stops immediately if there is an obstacle in the opening area or in the wall guide. This prevents injuries and damage to vehicles or property from the outset.



LOCKED. The elegant door handle with recessed grip ensures easy operation from both inside and outside. When closing, three hooks on the curve side and three security bolts on the closing side of the door leaf engage and firmly connect the door leaf to the side frame. On manually operated doors, a hook catch lock additionally secures the closing side.

→ Further information can be found on page 34.

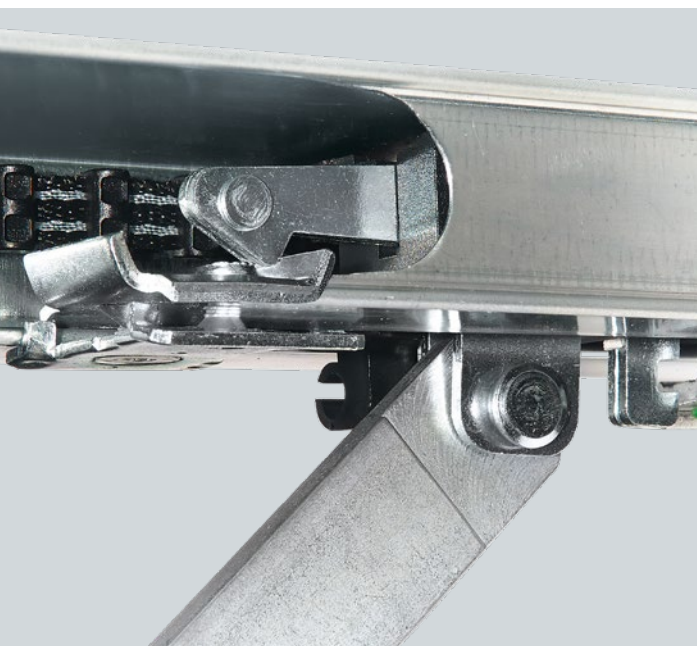

Only from Hörmann
Mechanical anti-lift kit in the operator boom

SECURE. On doors with operator, the anti-lift kit automatically engages in the boom's stop when closing, locks immediately and is secured against forced opening.



Watch the video on YouTube or at www.hormann.co.uk/videos

Intelligent operating comfort

Hörmann operators offer more convenience, smart functions and intelligent technology. Our elegant hand transmitters allow you to open your door from your car, for example. Or you can simply use your smartphone as a door opener with the Hörmann BlueSecur app or the Hörmann homee Smart Home control centre.





CERTIFIED SAFETY. The bidirectional radio system BiSecur with particularly secure encryption protocol and stable, interference-free range makes sure that no one can copy your radio signal. This is also confirmed by the security experts of Bochum University and independent test institutes.

Only from Hörmann



Watch the video on YouTube or at www.hormann.co.uk/videos

Only from Hörmann
Wicket door function

WICKET DOOR FUNCTION. Side sliding sectional doors can also be opened partially to allow pedestrian passage. This lets you get into your garage faster, for example if you want to get your bicycle out. The pedestrian passage width can be individually set for doors with operator. For example, to get a narrow passage for persons or a wider passage for bikes, motorcycles or wheelbarrows. The door is operated via the hand transmitter or the optional door handle with radio module.

→ Further information can be found on page 34.

A brief actuation of the handle and the door automatically moves into the set position.



With the homee Smart Home system, you can control all door functions via your tablet or smartphone.



Woodgrain surface finish

On this inexpensive and robust surface with an authentic sawn timber look, minor scratches can be easily repaired.

→ Available as L- and M-ribbed version. Further information can be found from page 20.



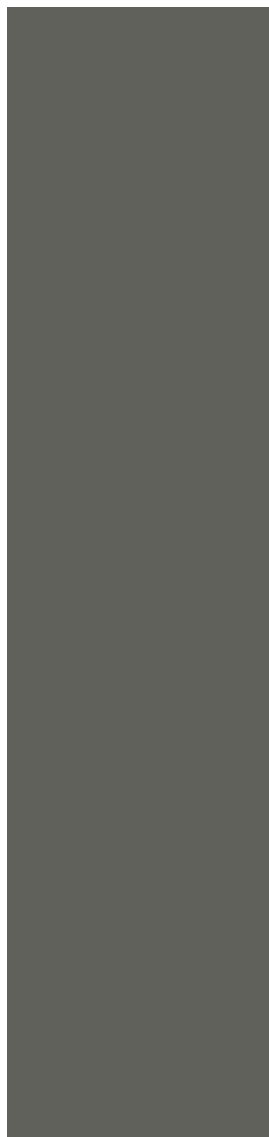

TOP LEFT. Detail view of Woodgrain, Traffic white RAL 9016

TOP RIGHT. M-ribbed, Woodgrain, Traffic white RAL 9016

BOTTOM LEFT. M-ribbed, Silkgrain, Quartz grey RAL 7039, Hörmann aluminium entrance door ThermoSafe style 860, Quartz grey RAL 7039

BOTTOM RIGHT. Detail view of Silkgrain, Quartz grey RAL 7039

Silkgrain surface finish

Thanks to its elegant door appearance, this silky smooth surface finish is the first choice for modern architecture.

→ Available as L- and M-ribbed version. Further information can be found starting on page 20.



The smooth Silkgrain surface finish harmonises particularly well with the entrance door surface finishes.

MatchColor, preferred colours

Use matching preferred colours for side sliding sectional doors, entrance doors, side doors and steel doors to design your home in perfect colour harmony.

→ Available for Woodgrain and Silkgrain surface finishes. For all colours and details, see from page 24.





TOP. L-ribbed, Silkgrain, Window grey RAL 7040 with matching side door

BOTTOM. L-ribbed, Silkgrain, Anthracite grey RAL 7016, Hörmann aluminium entrance door ThermoSafe style 860 in Anthracite grey RAL 7016



Side doors

The door as a second entrance to your garage is available in the same surface finishes, colours and decors as your garage door. This ensures that everything fits together.

→ Further information can be found on page 36.



Decograin surface finish

The detailed surface finish is available in five natural-looking timber designs and with an Anthracite metallic effect. Your door remains beautiful for a long time thanks to the special surface protection with UV-resistant plastic film coating on the outside of the steel sections.

→ Available as L- and M-ribbed version. Further information can be found starting on page 20.



Duragrain surface finish

With this smooth door surface, you can choose from detailed, natural and true-colour decors. The high-quality coating of high-strength protective paint is especially robust, scratch-resistant and stain-resistant. So your door can retain its flawless appearance for a long time to come.

→ Available as L-ribbed version. Further information can be found starting on page 20.



TOP LEFT. Detail view of Decograin Golden Oak

TOP RIGHT. M-ribbed, Decograin Golden Oak

BOTTOM LEFT. **NEW.** Detail Duragrain Corten Steel

BOTTOM RIGHT. **NEW.** L-ribbed, Duragrain Corten Steel

Design and light elements

Choose one of our design styles made of brushed stainless steel and give your door a particularly distinctive style. Additional glazings provide daylight in the garage.

→ Further information can be found on page 21.

TOP. L-ribbed design style 461 Silkgrain, White aluminium RAL 9006

BOTTOM. Aluminium frame door, Anthracite grey RAL 7016, Hörmann aluminium entrance door ThermoSafe style 860 in Anthracite grey RAL 7016





Aluminium frame door HART 42

This door version offers more light thanks to large glazings or better ventilation in the garage if grille infills are used. With a total of 12 different infill variants, the side sliding sectional door can be adapted to your individual requirements and design preferences.

→ For further information, see from page 22.

Steel sectional doors

Door leaf version and door styles



HST 42

- Good insulation and door travel properties
- Double-skinned 42 mm thick sections

Standard styles

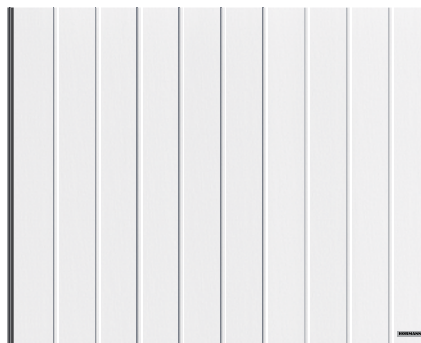

M-ribbed, Traffic white RAL 9016

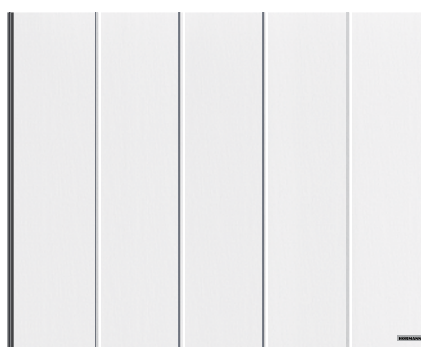

L-ribbed, Traffic white RAL 9016

Performance characteristics according to European standard 13241

Section material	Galvanized sheet steel with high-quality coating
Section thickness	Double-skinned, 42 mm
Thermal insulation U-value fitted door	1.7 W/(m ² ·K) ¹⁾
Wind load ³⁾	Class 2
Air / water tightness	Class 2 / Class 2 ²⁾
Max. width	6500 mm
Max. height	3000 mm

Styles / surface finishes

M-ribbed	Woodgrain, Silkgrain, Decograin
L-ribbed	Woodgrain, Silkgrain, Decograin, Duragrain

¹⁾ The U-value applies to fitted doors without glazing with the dimensions 4300 × 3000 mm

²⁾ Up to 70 Pa water pressure

³⁾ Higher wind load classes on request

Styles with design elements

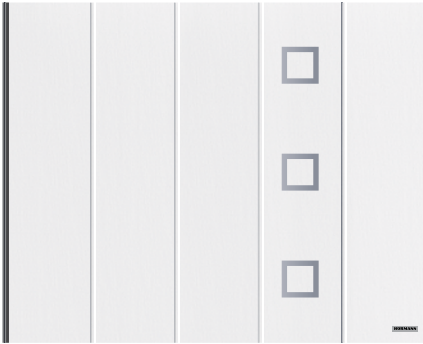

L-ribbed, Traffic white RAL 9016, design element style 451 ¹⁾

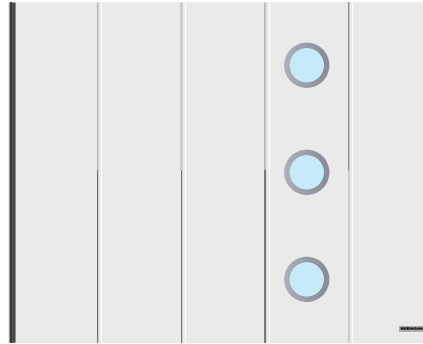

L-ribbed, Traffic white RAL 9016, design element style 469 ¹⁾

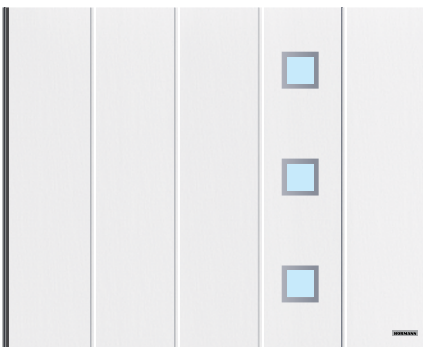

L-ribbed, Traffic white RAL 9016, design element style 461 ¹⁾



L-ribbed, Traffic white RAL 9016, design element style 481 ¹⁾

Design elements



Style 451 ¹⁾



Style 461 ¹⁾

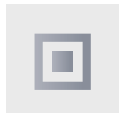

Style 452 ¹⁾

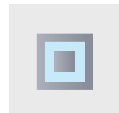

Style 462 ¹⁾



Style 471 ¹⁾



Style 481 ¹⁾



Style 459 ¹⁾



Style 469 ¹⁾



Style 472 ¹⁾



Style 482 ¹⁾



Style 473 ¹⁾



Style 483 ¹⁾



Style 453 ¹⁾



Style 463 ¹⁾



Style 456 ²⁾

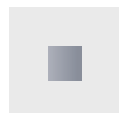

Style 460 ²⁾



Style 454 ¹⁾



Style 455 ¹⁾



Style 474 ¹⁾



Style 475 ¹⁾

Glazing

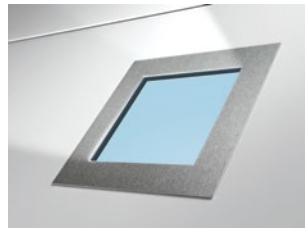

Design element in brushed stainless steel



Real glass
Optional for styles
461 and 481

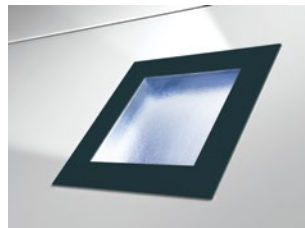

Design element painted in Anthracite grey RAL 7016 with synthetic glazing for styles 461, 462, 463, 469, 481, 482 and 483

¹⁾ 3 style pattern repetitions up to 2375 mm door height

²⁾ 4 style pattern repetitions up to 2375 mm door height

Aluminium frame doors

HART 42

Section view



HART 42 glazed, Traffic white RAL 9016

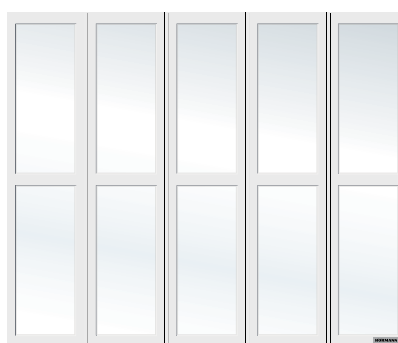

HART 42 glazed white tinted, Traffic white RAL 9016

HART 42

Frame material	Aluminium
Frame thickness	42 mm
Thermal insulation ART 42 U-value fitted door	4.0 W/(m ² ·K) ¹⁾
Thermal insulation ART 42 Thermo U-value fitted door	3.4 W/(m ² ·K) ¹⁾
Acoustic insulation	R = approx. 20 dB
Wind load ³⁾	Class 3
Air / water tightness	Class 2 ²⁾ / Class 3 ²⁾
Max. width	5500 mm
Max. height	3000 mm
Colours	Traffic white, 10 MatchColor preferred colours and 5 Color preferred colours, RAL to choose

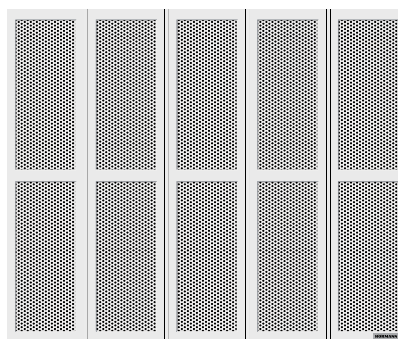

HART 42 with perforated sheet, Traffic white RAL 9016

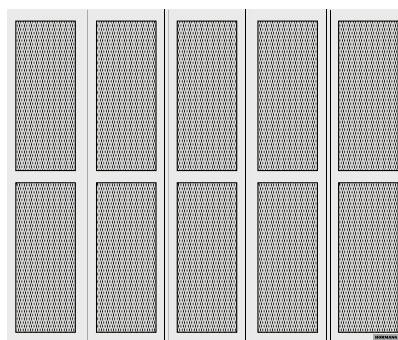

HART 42 with expanded mesh, Traffic white RAL 9016

¹⁾ U-values apply to fitted doors with synthetic double pane S2 with the dimensions 5000 × 2125 mm

²⁾ Doors with ventilation slots, classes 2 – 3 on request

³⁾ Higher wind load classes on request

Glazings and ventilation grilles

For more light and better ventilation

Glazing variations



Ventilation grille



Glazing variants for HST 42

- 1 Classic glazing S0¹⁾
- 2 Classic glazing S1¹⁾
- 3 Classic glazing S2¹⁾
- 5 Polycarbonate double pane, clear
- 8 Synthetic double pane, crystal structure

Ventilation grille for HST 42

- 4 Ventilation grille

Infill variations

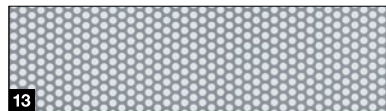
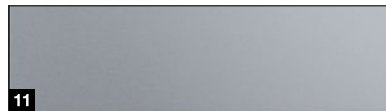
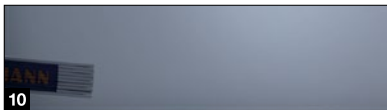
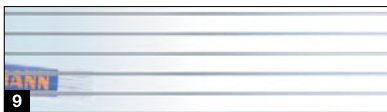
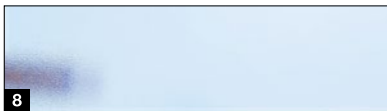
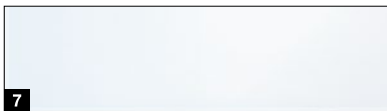
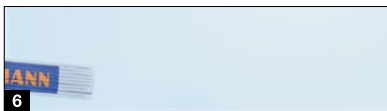
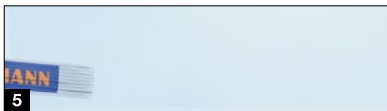

Infill variants for HART 42

- 5 Polycarbonate double pane, clear
- 6 Synthetic double pane, clear
- 7 Synthetic double pane, white tinted (opal / clear)
- 8 Synthetic double pane, crystal structure
- 9 Multiple-moulded pane
- 10 Synthetic double pane, grey tinted
- 11 PU sandwich infill, smooth
- 12 PU sandwich infill, Stucco
- 13 Perforated stainless steel sheet
- 14 Stainless steel expanded mesh
- 15 Crimped mesh
- 16 Welded grille

Illustrations (1 to 4) correspond to a door width of 2500 mm

¹⁾ Individual arrangement of glazings is possible

Clear synthetic glazings are available from Hörmann with Duratec glazing as standard.

It offers you decisive advantages:

- A permanently clear view
- Improved thermal insulation

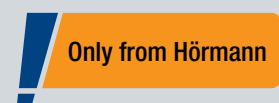

Duratec
Extremely scratch-resistant

Surface finishes

Woodgrain, Silkgrain

Woodgrain



Silkgrain



MatchColor

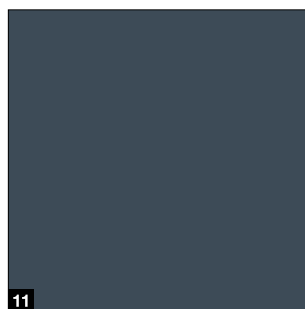
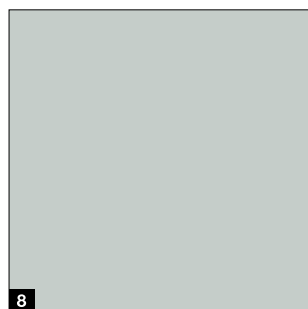
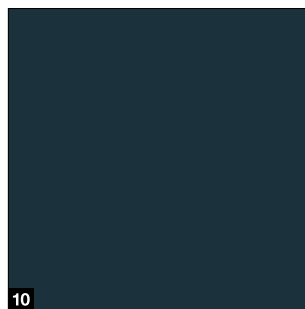
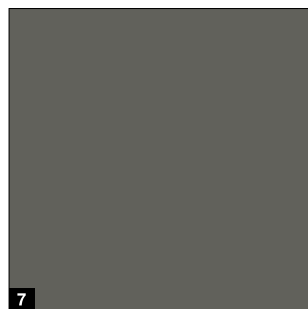
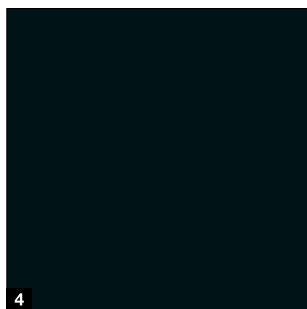
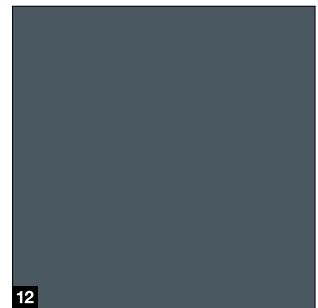
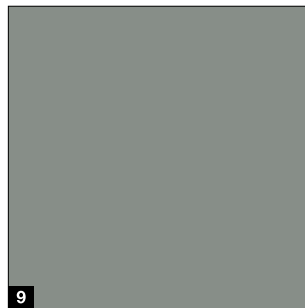
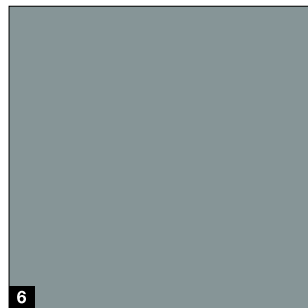
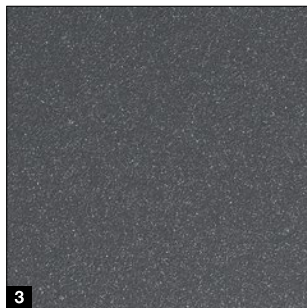

Please note:

In combination with the optional high-quality protective paint or "anti-graffiti" protective paint, all MatchColor preferred colours are available as a Color preferred colour for which a matching appearance of side sliding sectional doors, entrance doors, side doors and steel doors cannot be guaranteed.



MatchColor

Matching appearance of garage door,
entrance door, side door and steel door

Surface finishes

- 1 Woodgrain RAL 9016 Traffic white
- 2 Silkgrain RAL 9016 Traffic white

MatchColor

- 3 CH 703-AM Anthracite metallic
- 4 RAL 9005 Jet black
- 5 RAL 8028 Terra brown
- 6 RAL 7040 Window grey
- 7 RAL 7039 Quartz grey
- 8 RAL 7035 Light grey
- 9 RAL 7030 Stone grey
- 10 RAL 7016 Anthracite grey
- 11 RAL 7015 Slate grey
- 12 RAL 7012 Basalt grey

Colour

- 13 RAL 9007 Grey aluminium
- 14 RAL 9006 White aluminium
- 15 RAL 6009 Fir green
- 16 RAL 6005 Moss green
- 17 RAL 1015 Light ivory

RAL to choose

The Woodgrain and Silkgrain surface finishes are optionally available in around 200 RAL Classic colours (with the exception of pearl-effect and fluorescent colours) as well as in many NCS and DB colours.

Colour

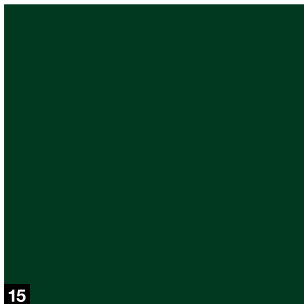
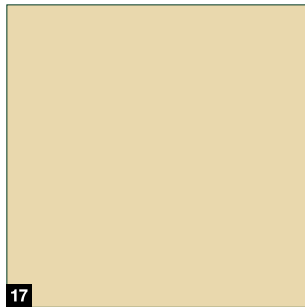
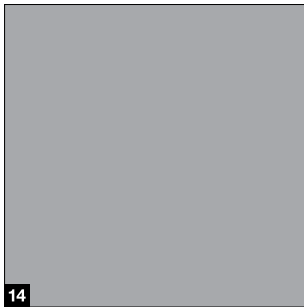

Please note:

Side sliding sectional doors are generally supplied in Grey white, RAL 9002, on the inside of the door. Dark colours should not be used for double-skinned steel doors that are exposed to the sun, as possible section deflection may damage the door.

All colours based on RAL. The colours and surface finishes shown are subject to the limitations of the printing process and cannot be regarded as binding.

Please consult with your local Hörmann sales partner.

Surface finishes

Decograin, Duragrain

Decograin

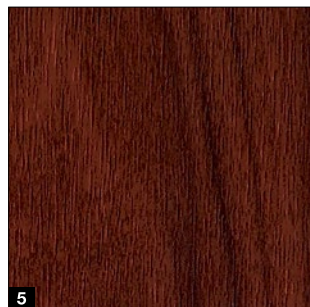

Decograin decors

- 1 Titan Metallic CH 703: Anthracite with a metallic effect
- 2 Golden Oak: Medium brown, golden yellow oak design
- 3 Dark Oak: Walnut-coloured oak design
- 4 Night Oak: dark, intense oak design
- 5 Rosewood: mahogany-coloured timber design
- 6 Winchester Oak: natural-coloured knotty oak decor

Please note:

Side sliding sectional doors are generally supplied in Grey white, RAL 9002, on the inside of the door. Dark colours should not be used for double-skinned steel doors that are exposed to the sun, as possible section deflection may damage the door.

All colours based on RAL. The colours and surface finishes shown are subject to the limitations of the printing process and cannot be regarded as binding.

Please consult with your local Hörmann sales partner.

Duragrain



Rusty Steel decor door appearance



Barnwood grey door appearance



Concrete door appearance



Door appearance MatchDecor Wild Oak, matching Hörmann aluminium entrance doors ThermoSafe MatchDecor



Duragrain
Extremely scratch-resistant

Scratch-resistant and stain-resistant

The innovative digital printing process, in combination with the high-strength protective paint, ensures that your door will look good for years to come.



- 1 Double-skinned section
- 2 Galvanisation
- 3 Primer coating
- 4 Innovative digital print
- 5 High-strength protective paint

Surface

Duragrain

Decors

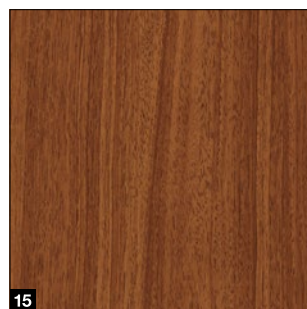
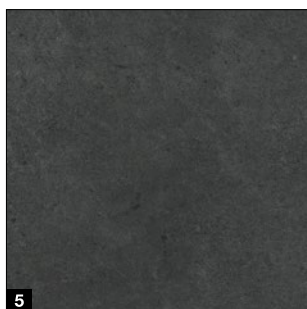
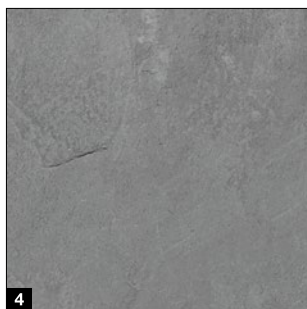
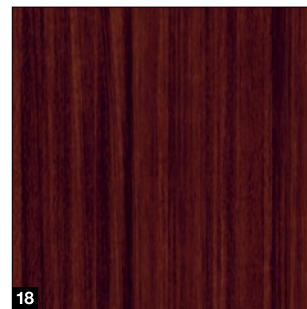
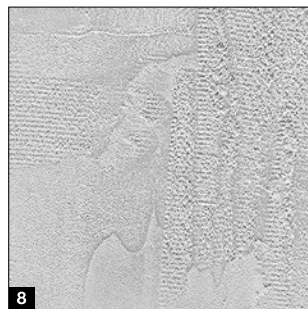
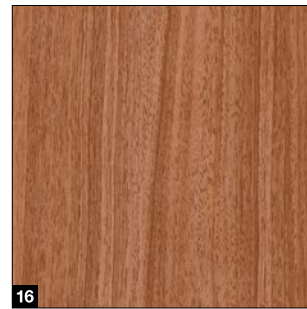
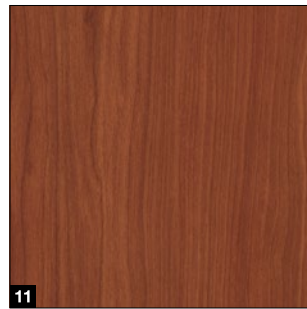
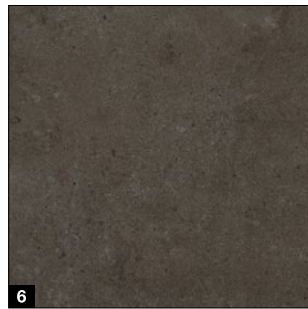
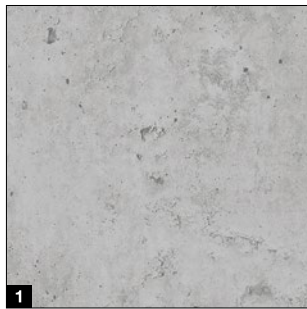

MatchDecor



MatchDecor
Matching appearance of
garage door and entrance
door

Decors

- 1 Concrete
- 2 Beige
- 3 **NEW.** Corten Steel
- 4 Grigio
- 5 Grigio scuro
- 6 Moca
- 7 Rusty Steel
- 8 **NEW.** Screed
- 9 Bamboo
- 10 Burned Oak
- 11 Cherry
- 12 Spruce
- 13 Malt Oak
- 14 Nature Oak
- 15 Noce sorrento balsamico
- 16 Noce sorrento natur
- 17 Rusty Oak
- 18 Sapeli
- 19 Sheffield
- 20 Barnwood grey
- 21 Teak
- 22 **NEW.** Toffee Oak
- 23 Used Look
- 24 **NEW.** Vintage Boards
- 25 Colonial Walnut
- 26 Terra Walnut
- 27 White brushed
- 28 White Oak
- 29 Whiteoiled Oak*
- 30 Whitewashed Oak*

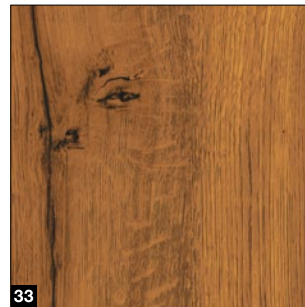
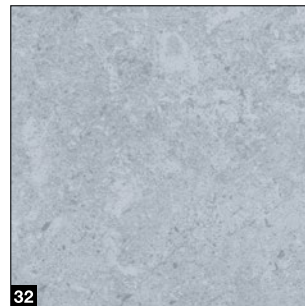
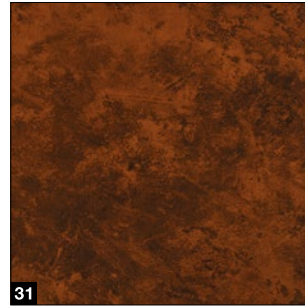
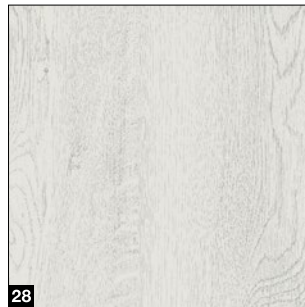
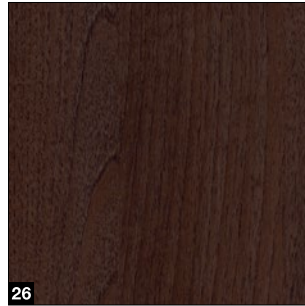
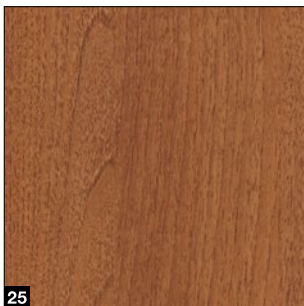

MatchDecor

- 31 Rusty Patina
- 32 **NEW.** Cement
- 33 Barnwood
- 34 Wild Oak

Surface protection

For a long and beautiful door appearance

High-quality coating

The sections are optimally protected by the double-sided hot-galvanized sheet steel in conjunction with the high-quality coating in Grey white RAL 9002 on the inside. For even better protection, you can also get the exterior of the sections with an optional high-quality protective paint. The high-quality Duragrain surface finish is offered with high-quality protective paint as standard.

Protective paints for a long and beautiful door appearance

High-quality protective paint

The surface finish of the sections is especially robust, scratch-resistant and stain-resistant thanks to the protective paint.

High-quality protective paint "anti-graffiti"

Due to the protective paint on the surface of the section as well as on glazings, design elements, etc., graffiti can be removed with a commercially available special cleaner.

→ Available for Woodgrain and Silkgrain surface finishes.



- 1 Double-skinned section
- 2 Galvanisation
- 3 High-quality coating
- 4 Optional: High-quality protective paint or high-quality protective paint "anti-graffiti"

Tested by Hörmann: Cleaning and maintenance set for a beautiful, long-lasting door design

Using the wrong cleaning equipment can often cause discolouration or leave unsightly scratches. With the cleaning and maintenance set, you're always on the safe side. The set has been developed together with Sonax, the market leader for cleaning and maintenance products for vehicle surfaces, and all components have been tested by Hörmann for use on steel garage doors as well as steel and aluminium entrance doors. It not only makes cleaning much easier but also reduces the risk of damaging the garage doors.

Matching appearance

For door leaf and frame

Only from Hörmann

Door leaf, fascia panel and side frames matching in Woodgrain Traffic white RAL 9016

Matching appearance of door frame and door leaf

The harmonious appearance of a door is the result of many small details: The fascia panel **1** provided always matches the door sections for all surface finishes. This ensures that everything fits together. The side frames **2** are available with a white Woodgrain surface finish as standard. With frame coverings **3**, the side frames can be easily adapted to the surface finish of the sections.

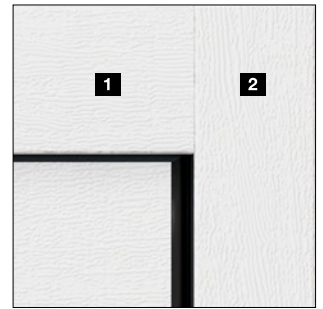

	Woodgrain	Silkgrain	Decograin	Duragrain
Fascia panel 1	●	●	●	●
Side frame 2	●	■	■	■
Frame covering 3	●	●	●	●

● = Identical surface, colour or decor same as door section
 ■ = Woodgrain surface finish in Traffic white RAL 9016



Standard equipment

For a secure and long-lasting door function





Precise door travel

Twin rollers **1** made of wear-resistant plastic move reliably and precisely on the aluminium rail and prevent the door sections from jumping out. Additionally, they ensure smooth and easy door travel, making it a breeze to operate the door by hand as well. Stable connecting hinges on the rollers and between the sections ensure high door leaf stability.

Perfectly guided and well-sealed

The bottom aluminium floor rail **2** reliably guides the door sections and prevents the sections from slipping out. The flat design allows barrier-free access. Thanks to its continuous threshold seal the side sliding sectional door impresses with class 2 water tightness and air permeability. This makes the door well-sealed against penetrating rainwater and leaves. This keeps the garage cleaner for longer which means it must be cleaned less often. In addition, the risk of accidents by slipping is reduced.

Securely locked

The bottom and top door guides close the door precisely. Three additional hooks on the curve side **3** and three security bolts on the closing side **4** of the door firmly connect the door leaf ends to the side frame. Furthermore, these mechanical security devices virtually prevent the door from being forced open.

Easy fitting

The frame of the side sliding sectional door can be easily screwed together and then fastened completely to the garage wall. Fitting in tight areas with only 140 to 450 mm sideroom is made possible with the DS track application **5** with double side guides. The side track can be easily fitted with the adjustable wall brackets. The optional aluminium frame **6** can be completely pre-assembled before alignment and fastening to the garage wall. This saves a considerable amount of time during fitting. Additionally, the reinforced construction of the frame simplifies installation on uneven walls and is therefore particularly suitable for renovations.



Optional equipment

Handles for internal and external operation

Handles



As standard, side sliding sectional doors are delivered without a door handle. The optional door handles are positioned vertically on the door leaf and are equipped with profile cylinder, security rose escutcheon, drill-proofing and core pull-off protection. In addition, you can receive the cylinder with a knob on the inside on request. The elegant door handle with recessed grip ensures easy operation from both inside and outside. For a harmonious door appearance, you can choose from three colours for the outer shell.

Cast metal outer shell in three colours

- 1 Traffic white RAL 9016
- 2 Jet black RAL 9005
- 3 Stainless steel look



For manually operated doors: Door handle with hook catch lock

The hook catch engages when the door is closed and locks the closing side.

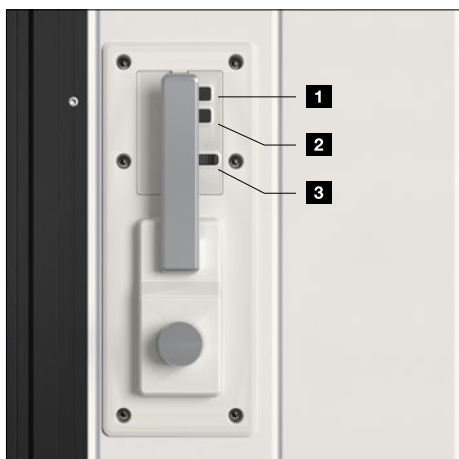

For doors with operators: Door handle incl. convenient wicket door function

Two buttons and a sliding switch on the interior side of the handle allow you to:

- 1 Completely open and close the door
- 2 Operate the wicket door function
- 3 Switch off the radio signal (away setting)

NEW. Sliding doors

Convenient as a side door



The new sliding door design with a clear passage width of 730 mm or more is a space-saving alternative to conventional side doors. This version is pushed to the side and does not need any space in the garage to open the door leaf. This ensures efficient use of garages with limited space while providing greater flexibility for side entrances.

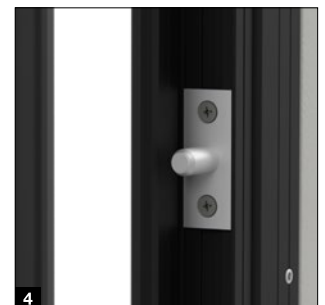

- 1 Exterior handle with profile cylinder
- 2 Twin rollers
- 3 Interior handle with hook catch lock
- 4 Security bolt on the closing side

Side doors

Garage side doors NT 60

Door sizes*

- Width (single-leaf) 990 – 1115 mm
- Width (double-leaf) 1130 – 3000 mm
- Height (single- / double-leaf) 1990 – 2183 mm

Leaf frames

- Wide version (profile type 4)

Standard equipment

- 60 mm thick weather-resistant aluminium profiles in the colour of the sections or, in the case of Duragrain infills, in a colour matching the decor **1**
- Traffic leaf with black plastic lever handle set with oval rose escutcheons and profile cylinder lock **2**
- 3-way adjustable hinges optionally in black, white or aluminium natural finish **3**



Optional equipment

- Lever handle or lever / knob handle sets in brushed stainless steel **4**, aluminium natural finish **5**, cast aluminium RAL 9016 **6**, black cast aluminium **7**
- Concealed hinges for an elegant door view in the version with aluminium block frame **8**
- Fixed bolt for locking the fixed leaf with double-leaf side doors **9**
- Break-in-resistant RC2 security features with 3-point-locking (latch, bolt, 2 locking hooks) and security rose escutcheon **10**
- Double-leaf side doors with asymmetrical division (not shown)

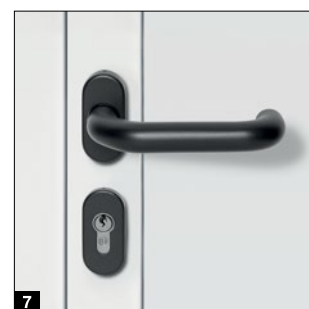
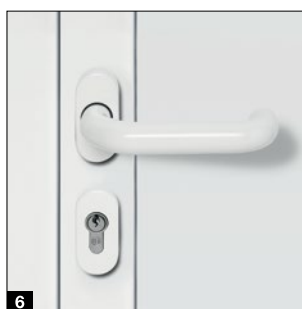
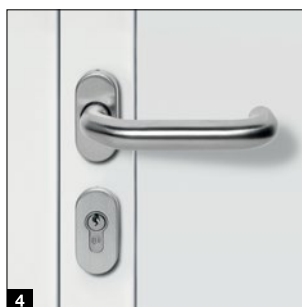
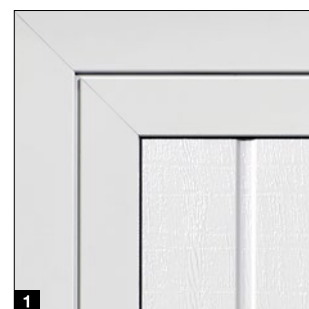
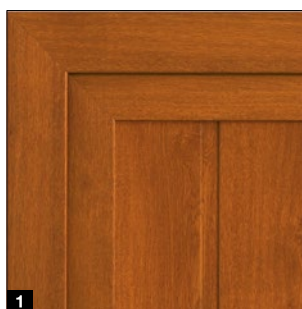



Multi-purpose door MZ Thermo65

Steel side doors with thermal break

- 65 mm thick door leaf with thermal break and PU rigid foam infill
- Aluminium block frame with thermal break and threshold with thermal break
- High thermal insulation with a U-value = 0.82 W/(m²·K)
- Optionally available in an RC2 version as KSI Thermo46 with a 46 mm thick door leaf



For further information, see the "Steel doors" brochure.

Operators

SupraMatic 4

Supra-fast door opening and smart additional functions

- 40% faster opening speed* up to 20 cm/s
- Smart operation with the BlueSecur app
- Convenient garage ventilation
- Additional opening position
- Up to 3 times (SupraMatic E) or 5 times* (SupraMatic P) brighter LED lighting
- Easy-to-use programming thanks to 2 × 7-segment display
- High-quality stainless steel operator cover
- Networked with Smart Home systems via the standard HCP interface



 **BiSecur**

As standard with two 4-button hand transmitters HSE 4 BS, textured surface black with chrome caps

Garage door operators	SupraMatic E	SupraMatic P
Bluetooth receiver	Integrated, can be switched on and off	Integrated, can be switched on and off
HCP bus connection	Integrated	Integrated
Cycles per day / hour	25 / 10	50 / 10
Pull and push force	650 N	750 N
Peak force	800 N	1000 N
Max. opening speed	20 cm/s	20 cm/s
Lighting	20 LEDs	30 LED chase light
Max. door width	6000 mm	6500 mm
Max. door surface	13.75 m ²	15 m ²

* In comparison with the ProMatic series 3

Only from Hörmann
European patent

 **Hörmann BlueSecur**



Operation by smartphone using the Hörmann BlueSecur app

Premium quality at an attractive price

- 20% faster opening speed* up to 17 cm/s
- Convenient garage ventilation
- Additional opening position
- Up to 2 times* brighter LED lighting
- Networked with Smart Home systems via the standard HCP interface



 **BiSecur**

As standard with two 4-button hand transmitters HSE 4 BS, textured surface black with plastic caps

Garage door operators

ProMatic 4

Bluetooth receiver	Optional (HET-BLE)
HCP bus connection	Integrated
Cycles per day / hour	25 / 10
Pull and push force	650 N
Peak force	800 N
Max. opening speed	17 cm/s
Lighting	10 LEDs
Max. door width	5000 mm
Max. door surface	11.25 m ²

Accessories

Hand transmitter



HS 5 BS
4 button functions plus query button, high-gloss surface black or white



HS 5 BS
4 button functions plus query button, textured surface matt black



HS 4 BS
4 button functions, textured surface matt black



HS 1 BS
1 button function, textured surface matt black



HSE 1 BS
1 button function, including eyelet for key ring, textured surface matt black



HSE 4 BS
4 button functions, incl. eyelet for key ring, textured surface matt black with chrome or plastic caps



HSE 4 BS
4 button functions, incl. eyelet for key ring
High-gloss surface with chrome caps, colours (shown from left): White, Anthracite Grey, Frozen Grey, Classic Grey, Carbon, Silver



HSD 2-C BS
High-gloss chrome, 2 button functions, can also be used as a key ring



HSZ 1 BS / HSZ 2 BS
1 or 2 button functions, for insertion in vehicle cigarette lighter



HSI 3 BS
To control up to 3 doors, with extra-large buttons, impact-resistant housing, protection category: IP 65

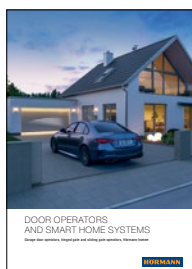

Further information can be found in the "Door operators and Smart Home systems" brochure.



Radio code switch FCT 3 BS
3 functions, with illuminated buttons, recessed or surface-mounted fitting possible, plastic housing in Light grey RAL 7040 (also available with 10 functions and hinged cover, painted in White aluminium RAL 9006)



Radio code switch FCT 10 BS
10 functions, with illuminated buttons and hinged cover, recessed or surface-mounted fitting possible, plastic housing painted in White aluminium RAL 9006



Radio finger-scan FFL 25 BS
2 functions and up to 25 fingerprints, with hinged cover, recessed and surface-mounted fitting possible, plastic housing painted in White aluminium RAL 9006



Radio internal push button FIT 5 BS
4 button functions plus query button, plastic housing in Pure white RAL 9010

Button



Radio internal push button FIT 2-1 BS
2 functions, connection option for max. 2 control elements via cable, e.g. key switch, plastic housing in Pure white RAL 9010



Internal push button IT 1b-1
Large, illuminated button for convenient opening of the door, plastic housing in Pure white RAL 9010



Transponder key switch TTR 1000-1
1 function, 1000 teachable keys, scope of delivery: 1 key and 1 card (more on request), zinc die-cast housing in White aluminium RAL 9006



Code switch CTP 3-1
3 functions, with illuminated lettering and touch-sensitive black surface, zinc die-cast housing in White aluminium RAL 9006



Code switch CTV 3-1
3 functions, particularly robust with metal keypad, zinc die-cast housing in White aluminium RAL 9006 with stainless steel panel



Finger-scan FL 150
2 functions, control via fingerprint, up to 150 savable fingerprints, zinc die-cast housing in White aluminium RAL 9006 with stainless steel panel



Key switch
1 STUP 50
2 STAP 50
Recessed version and surface-mounted version, incl. 3 keys, zinc die-cast housing in White aluminium RAL 9006 with stainless steel panel



Internal climate sensor HKSI
For monitoring humidity and automatic ventilation of the garage, plastic housing in Pure white RAL 9010
External sensor HKSA
For measuring outdoor humidity, plastic housing in Pure white RAL 9010

Dimensions and technical manual

HST 42 without wicket door

Operator wall fitting

Vertical view

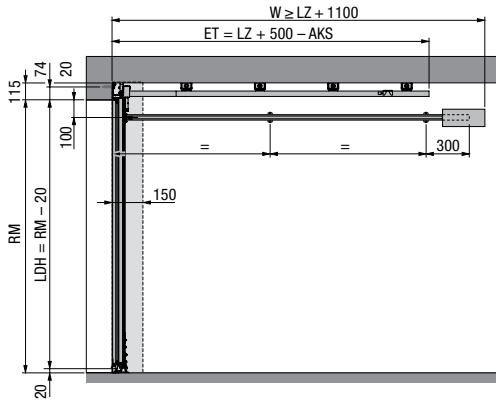

Operator ceiling fitting

Vertical view

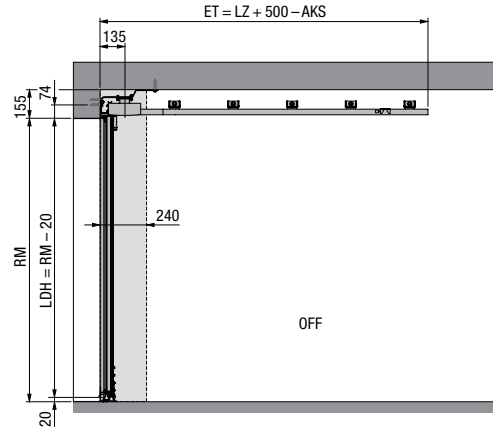

Track application ES (single track, operator wall fitting)

Horizontal view

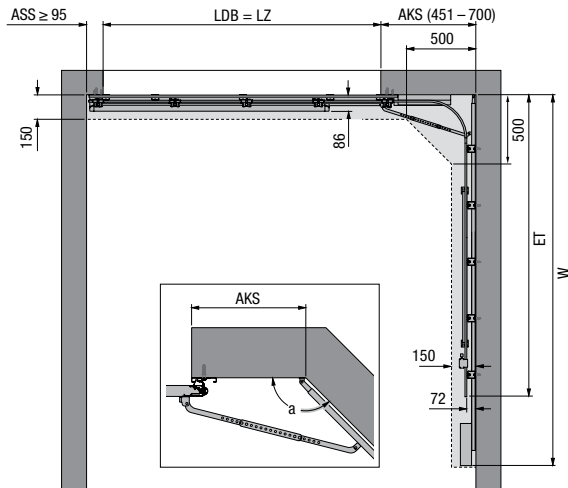

Track application ES (single track, operator ceiling fitting A)

Horizontal view

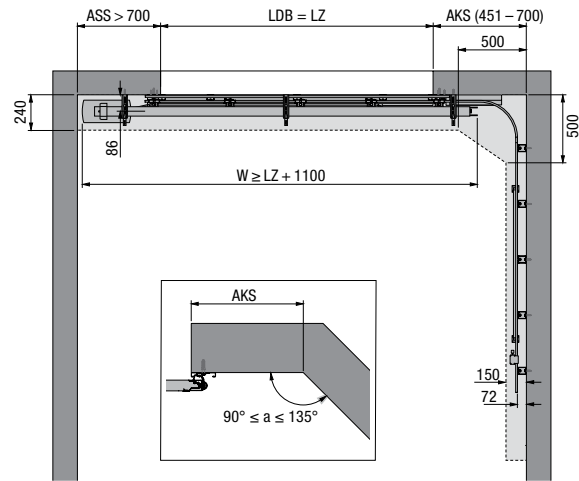

Track application DS (double track, operator wall fitting)

Horizontal view

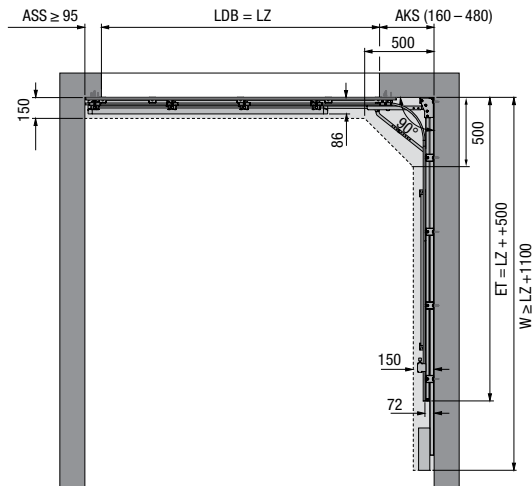

Track application ES (single track, operator ceiling fitting B)

Horizontal view

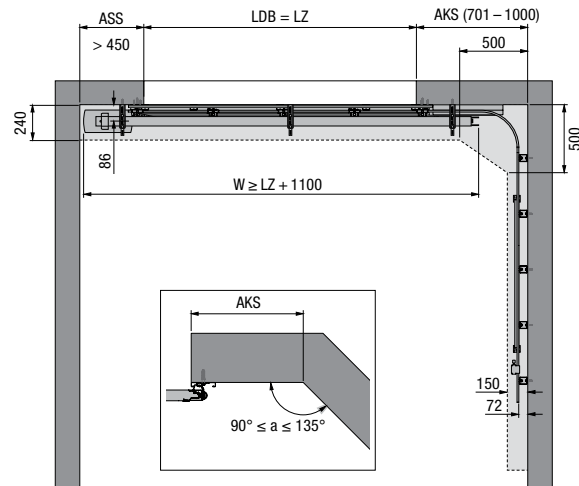

Size range (max.)¹⁾

Grid height (RM)	3000	Operator-driven doors																									
	2850	Operator-driven doors																									
	2750	Operator-driven doors																									
	2600	Operator-driven doors																									
	2500	Operator-driven doors																									
	2375	Operator-driven doors																									
	2250	Operator-driven doors																									
	2205	Operator-driven doors																									
	2125	Operator-driven doors																									
	2080	Operator-driven doors																									
	2000	Operator-driven doors																									
	1900	Operator-driven doors																									
			Clear frame dimension (LZ)																								
		2000	2080	2125	2205	2250	2375	2500	2600	2750	2850	3000	3125	3275	3500	3750	4000	4250	4500	4750	5000	5250	5500	5700	6000	6300	6500
		4	4	4	4	4	5	5	5	5	6	6	6	7	7	8	8	8	9	10	10	10	11	12	12	12	13
		No. of sections																									

 Operator-driven doors
  Manually operated doors, L-ribbed

¹⁾ Intermediate widths are also available for M-ribbed and L-ribbed doors.

Determining the operator boom

ES and DS track applications

Clear frame dimension (LZ)	Operator boom	Distance back (overall length of operator SupraMatic / ProMatic)
≤ 2205	K	3200
≤ 2375	M	3450
≤ 3000	L	4125
≤ 3275	XL	4375
≤ 4750	5500	5725
≤ 6500	7000	7225

The distance back (overall length of operator) can be shortened on site up to LZ + 1100 mm.

The side guide can be set back up to 125 mm if the distance back (overall length of operator) is smaller than LZ + 1100 mm.

Explanations

RM	Grid height (ordering size)
LZ	Clear frame dimensions (ordering size)
LDH	Clear passage height
LDB	Clear passage width
ET	Distance back (overall length with operator)
OFF	Finished floor level (FFL)
ASS	Closing side sideroom
AKS	Curve side sideroom

For further information, please see the technical manual or contact your Hörmann partner.

Dimensions in mm

Hörmann. For Life.

Whether you are building your home or modernising it, you desire a place full of joy, security and relaxation. Thanks to their sustainable and particularly durable quality, Hörmann products will become a reliable part of your home – made to last for generations.

GARAGE DOORS. GATE AND DOOR OPERATORS. SMART HOME SYSTEMS. ENTRANCE DOORS. RESIDENTIAL INTERNAL DOORS. LOFT DOORS. STEEL DOORS. DOOR FRAMES. STORAGE SPACE SYSTEMS.



Some of the products shown feature special equipment and do not always correspond to the standard versions. The surface finishes and colours shown are subject to the limitations of the printing process and cannot be regarded as binding. All RAL colours are based on the RAL colour chart. Protected by copyright. No part may be reproduced without our prior permission. Subject to changes.

HÖRMANN